



FLT Lens Series for LG Innotek 3535 Ceramic¹ LEDs

- High efficiency
- Available in 3 different beams
- Easy assembly

The FLT lens series offers three lenses specifically designed for the 3535 Ceramic LEDs from LG Innotek¹.

A software-optimized aspheric profile combined with shaped front surfaces and micro-lenses provide several different beam output patterns: medium, wide and elliptical beams².

The design of the FLT series insures that almost all of the light emitted by the LED is captured and usefully directed, resulting in a lens with maximum performance and efficiency.

The FLT series is available as lenses alone or as assemblies in black, white or transparent holders. The lens assemblies allow for easy and accurate assembly of the FLT lens to your LED and fixture.

Typical applications are:

- Reading lamps
- MR11 and MR16 Fixtures
- Signs
- Architectural Lighting



1. 3535 Ceramic is a trademark of LG Innotek. For technical information about the LEDs, please refer to the 3535 Ceramic LED datasheet or visit ledlighting.lginnotek.com/products/pkg.jsp.
2. Typical beam divergence may change with LED binning and color.

FRAEN Corporation OMG	FRAEN Corporation Srl
80 Newcrossing Road	Via delle Querce, 26
Reading MA 01867	27020 Trivolzio (PV)
USA	Italy
Phone: +1 781.205.5300	Phone: +39 0382 1933.1
Fax: +1 781.942.2426	Fax: +39 0382 1933.239

Inquiries: optics@fraen.com
Website: FraenOMG.com

For ordering or sales information in your region, please contact one of our offices listed above or visit www.FraenOMG.com/Contact.



General Characteristics

Materials

Lens Material	Optical Grade PMMA
Holder Material	Polycarbonate: Transparent, White or Black
Operating Temperature range	-40° C / + 80° C
Storage Temperature range	-40° C / + 80°C

Average transmittance in visible spectrum (400 – 700nm) >90%, as measured using 3mm thick Optical Grade PMMA.

Please note that flow lines and weld lines on the external surfaces of the lenses are acceptable if the optical performance of the tri-lens is within the specification described in the section “OPTICAL CHARACTERISTICS”

IMPORTANT NOTE – Lenses handling and cleaning:

- *Handling: Always use gloves to handle lenses and/or handle the lenses only by the flange. Never touch the outside surfaces of the lenses with fingers; finger oils and contamination will absorb or refract light.*
- *Cleaning: Clean lenses only if necessary. Use only soap and water to clean the surfaces and lenses. Never expose the lenses to solvents such as alcohol, as it will damage the plastic.*

Scope

This datasheet provides information about the FLT series:

	<u>Lens alone</u>	<u>Black holder</u>	<u>White Holder</u>	<u>Transparent Holder</u>
Medium Beam	FLT-M1-R	FLT-M1-TSB	FLT-M1-TSW	FLT-M1-TST
Wide Beam	FLT-W1-R	FLT-W1-TSB	FLT-W1-TSW	FLT-W1-TST
Elliptical Beam	FLT-E1-R	FLT-E1-TSB	FLT-E1-TSW	FLT-E1-TST



Optical Characteristics¹ – On-axis Intensity², Beam Angle³, Field Angle⁴

LED	Beam Shape	On-axis Intensity (peak)	Beam Angle (FWHM)	Field Angle (FW10%)
3535 Ceramic	Medium	3.1 cd/lm	20°	43°
	Wide	1.4 cd/lm	33°	65°
	Elliptical	1.7 cd/lm	22° x 36°	49° x 69°

- (1) Typical performance
- (2) To calculate the on-axis intensity (cd), multiply the on-axis value, above, of the lens (cd/lm) by the total flux (lm) of the LED used. See “Illumination Calculations” below. Luminous intensity depends on the flux binning and tolerances of the LEDs. Please refer to the LED datasheet for more details on flux binning.
- (3) FWHM is the full angle where the beam intensity is half the on-axis peak intensity
- (4) Field angle is the full angle where the beam intensity is 10% of the on-axis peak intensity

Example Calculations

To calculate intensity (cd): Find the central spot on-axis intensity (cd/lm) for the lens and then multiply this value by the luminous flux (lm) of the LED. Refer to the LED’s datasheet for typical flux values; drive current versus flux ratios; color temperature and binning characteristics.

Example intensity calculations:

If a Fraen lens with an on-axis intensity of 21 candela per lumen (cd/lm) is used with an LED that produces 105 lumens of flux, the calculations are as follows:

On-axis intensity = (21 cd/lm) x (105 lumens) = 2205 candela on-axis intensity (one LED).

If 12 LEDs are used in a fixture, then the on-axis intensity = 12 LEDs x 2205 candela/LED
= 26460 cd (on-axis – 12 LEDs)

An explanation of illuminance and the effect of distance

One candela at 1-meter distance produces 1 lux. In the above example, the 12 LED fixture produced 26460 candela. If that fixture is illuminating a surface one meter distant, then the *illuminance* on that surface is 26460 lux.

Illuminance decreases with the square of the distance. If you move the fixture so that it is two meters from the surface, then the illuminance falls to 26460 lux/ (2m)² or 6615 lux. Moving the fixture three meters from the surface decreases the illuminance to 26460 lux/(3m)² or 2940 lux.

Beam and Field Angles

Beam and Field Angles are methods of describing the light distribution of a lens. The Beam Angle is expressed as a FWHM value (Full angular Width of the beam where it reaches Half the



Maximum intensity). The Field Angle is a similar concept, sometimes expressed as FW10%, and represents the Full Width angle where the beam reaches 10% of maximum intensity.

If the lenses in our example fixture, above, have a Beam Angle of 10° and an on-axis intensity of 26460 cd, then at $\pm 5^\circ$ (half of 10°) the intensity will drop to half of 26460 or 13230 cd. If the Field Angle for the fixture is 19° , then at $\pm 9.5^\circ$ (half of 19°) the intensity should be 10% of 26460 or 2646 cd.

Most lenses have Beam and Field Angles that are rotationally symmetrical about the center axis of the lens. Lenses with an elliptical beam profile or optics with specifically shaped beam profiles are the exception.

Intensity, illuminance, Beam and Field Angle are all important factors to be considered in a fixture design. Some applications may require specific ratios between the Beam and Field Angle values.

Mechanical Characteristics

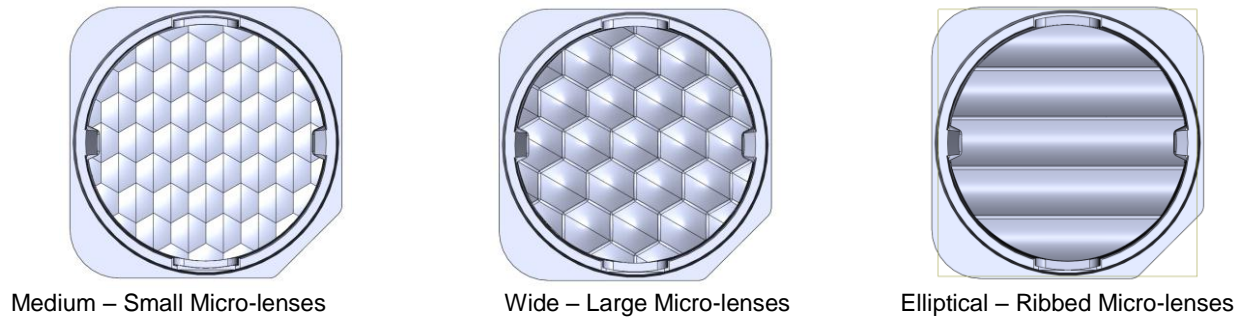

Figure 1: Identifying the lenses by their front appearance

The FLT series is available as an assembly (lens and holder) or as a lens alone. The holder provides the correct alignment (concentricity, height and orientation) between the lens and the LED. Orientation control is very important for proper lens performance (all beam angles) and beam alignment (elliptical lens).

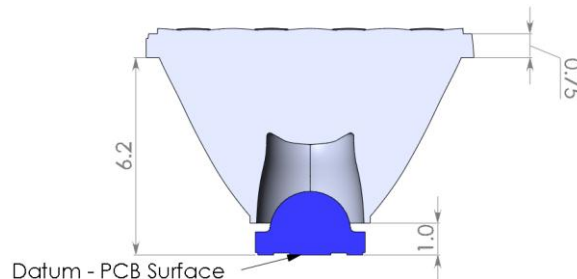

Figure 2. Lens cross section showing the correct vertical mounting position



NOTE: When using a lens alone, the user must provide a mechanical method to set the correct position of the lens on the LED. For example, the lens flange can be located in the lamp housing to center the lens to the LED and establish 6.2 mm from the bottom of the lens flange to the user's PC board. When the lens is positioned correctly, the bottom of the lens is 1.0 mm above the surface of the PCB and concentric with the dome of the LED.

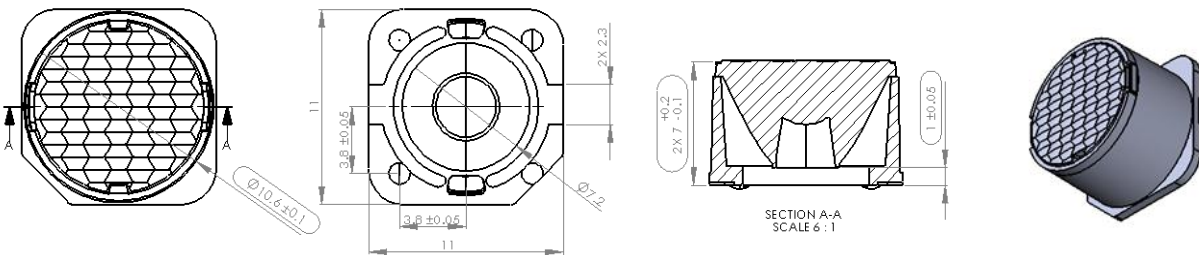

Figure 3: FLT Assembly - Top, Bottom, Section and Isometric views with dimensions

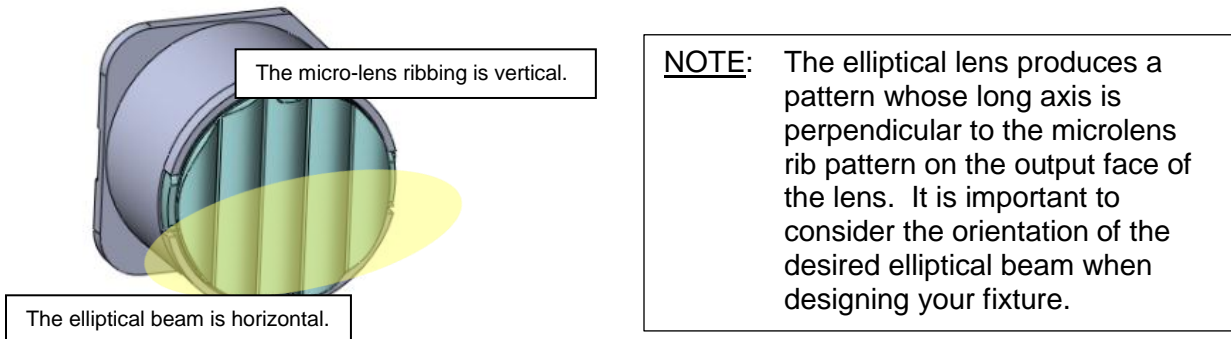

Figure 4: Design considerations when using an Elliptical Lens



The FLT series lens assemblies are design to provide the correct positioning and alignment of the lens to the LED. The bottom of the FLT assembly has four pins that fit into corresponding recesses on the PCB. When properly installed, the flat bottom of the assembly should be in contact with the top of the PCB to provide proper height alignment.

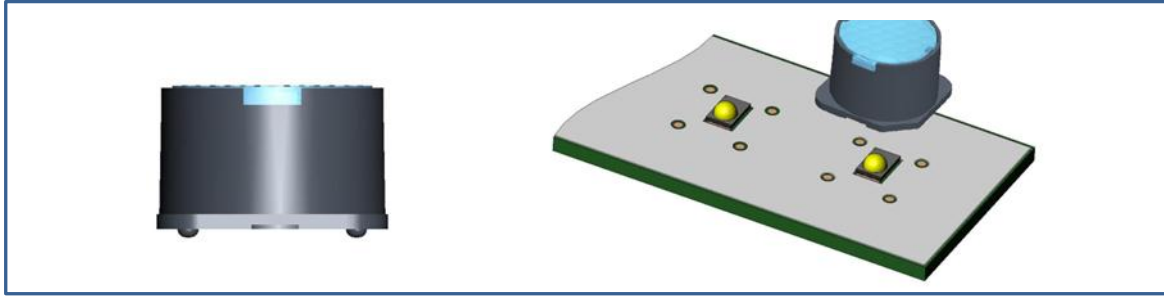

Figure 5: Views of the FLT assembly and the assembly with a PCB showing assembly alignment pins and corresponding recesses in the PCB.

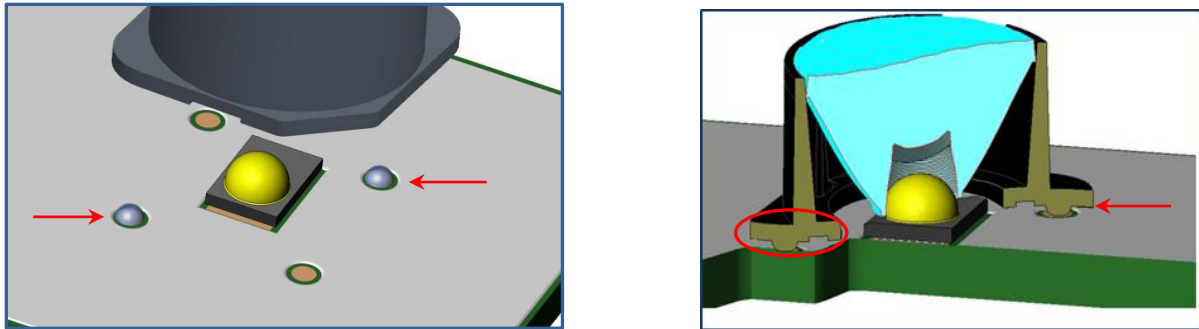

Figure 6: FLT assemblies can be fastened to the PCB by placing a small drop of glue in one or more of the pin recesses on the board. When properly attached, the alignment pin rests in the board recess and the flat bottom of the assembly is in contact with the top of the PCB.

Packaging

FLT lenses are supplied in trays only. FLT assemblies are supplied in Tape & Reel packaging only. Reels contain 500 FLT assemblies. Each reel is individually bagged and boxed and then packaged 10 reels to a case.

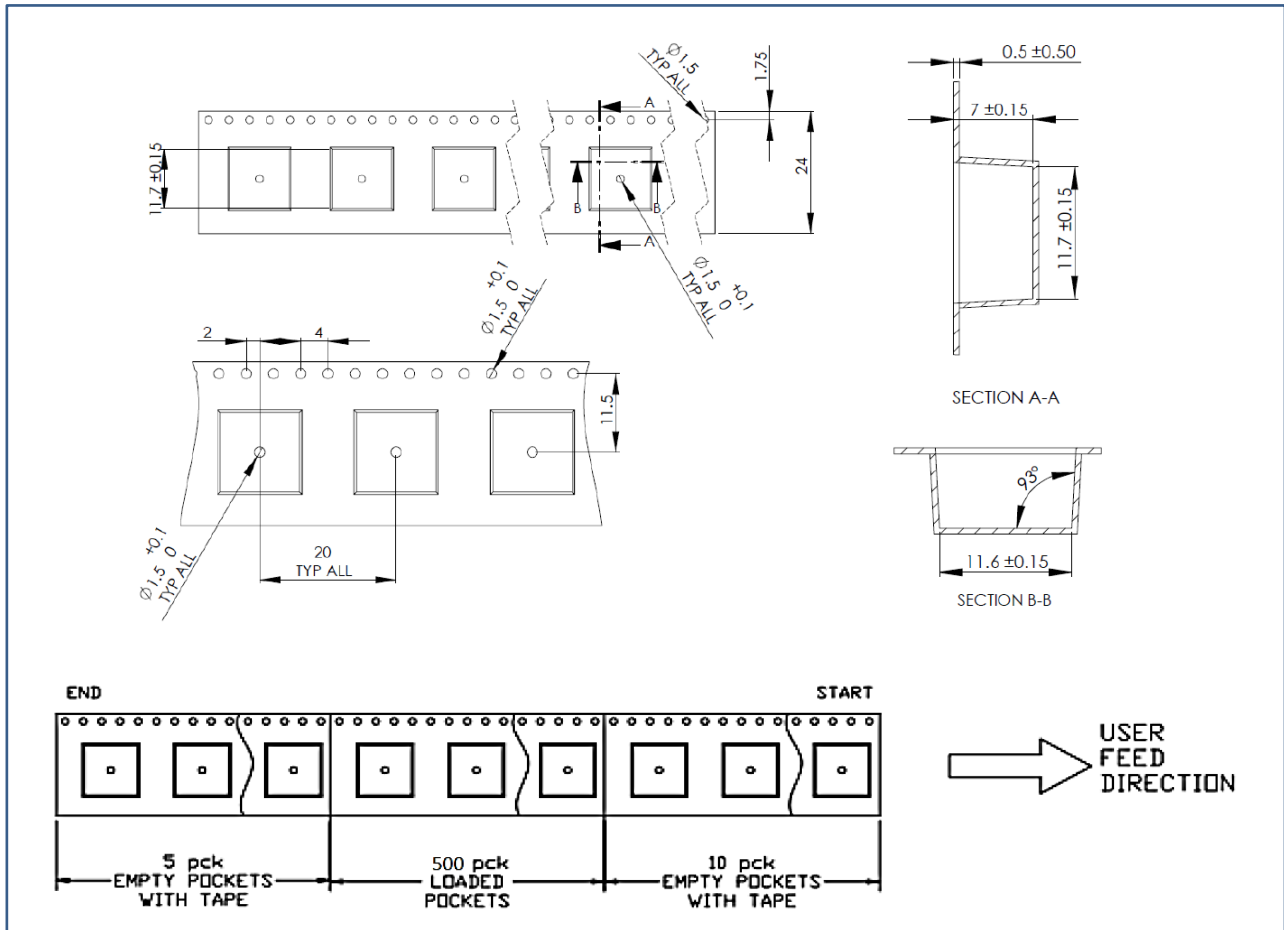

Figure 7: Details of the Tape & Reel packaging (all dimensions in millimeters)

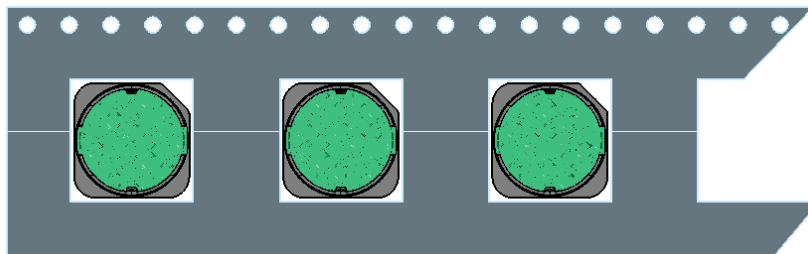

Figure 8: Showing orientation of the FLT assemblies in the tape pockets



Ordering Part Numbers

FLT- _1-[]

R: Lens alone
TSB: Lens in a black holder
TSW: Lens in a white holder
TST: Lens in a transparent holder

M – Medium Beam
W – Wide Beam
E – Elliptical Beam

© Copyright 2012 Fraen Corp. All rights reserved.